



RENTALS & SALES

"We guarantee fast service, no matter how long it takes"

509-534-2619

6602 E. MAIN AVE • SPOKANE, WA 99212



NATIONALBARRICADEANDSIGN.COM



Message Board



Arrow Board



Radar Speed Signs



AFAD - Flagger Device



Light Tower



SIGNS

CONSTRUCTION | WARNING | GUIDE | REGULATORY | STREET SIGNS | CUSTOM SIGNS

Construction Signs

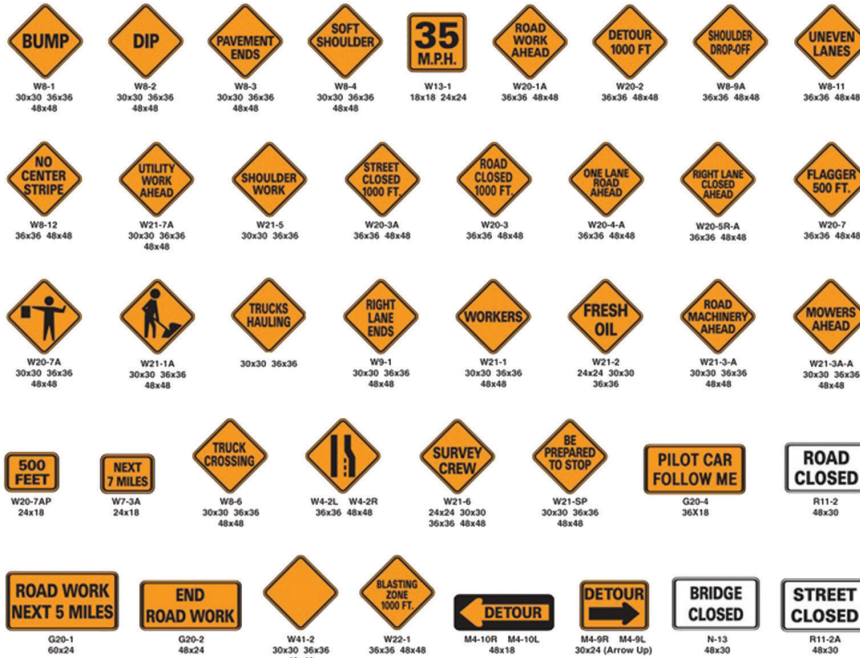

Regulatory Signs

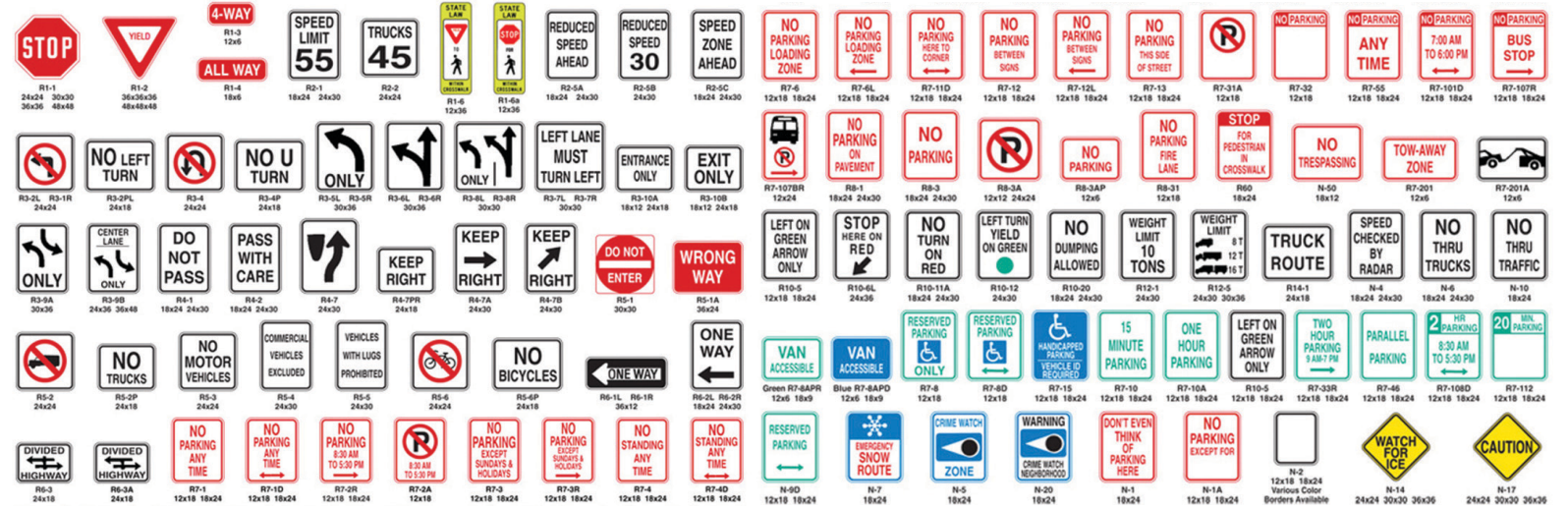



SIGNS

CONSTRUCTION | WARNING
GUIDE | REGULATORY
STREET SIGNS | CUSTOM SIGNS

Construction Signs

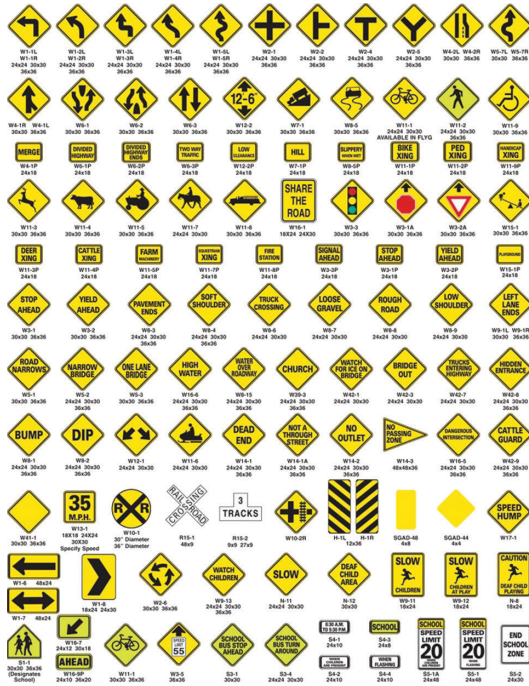

Custom Signs

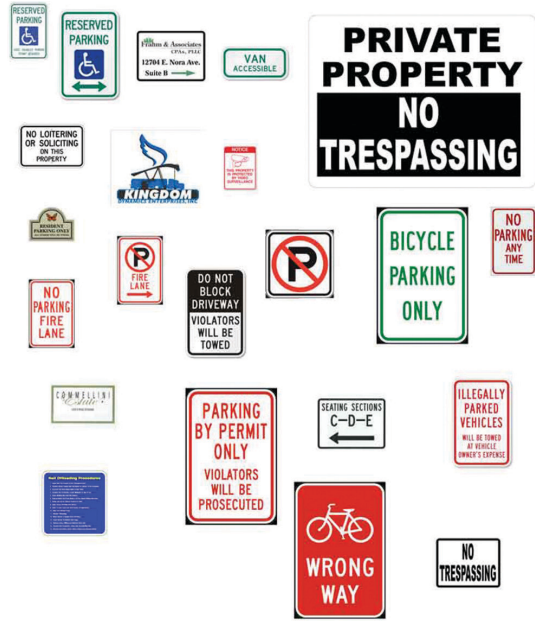

Guide Signs & Street Signs

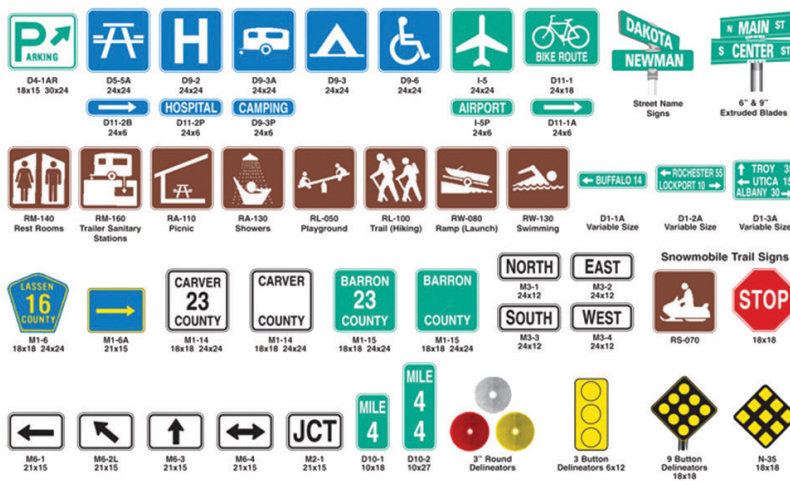

OSHA Signs





EQUIPMENT

SALES
RENTALS

TRAILER MOUNTED ANTENUATORS | AUTOMATED FLAGGING DEVICES | ROADQUAKES



Message Boards



Mini Message Boards

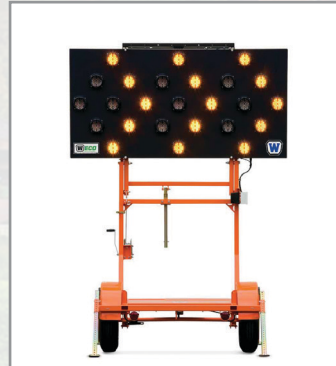

Arrow Boards



Radar Trailer

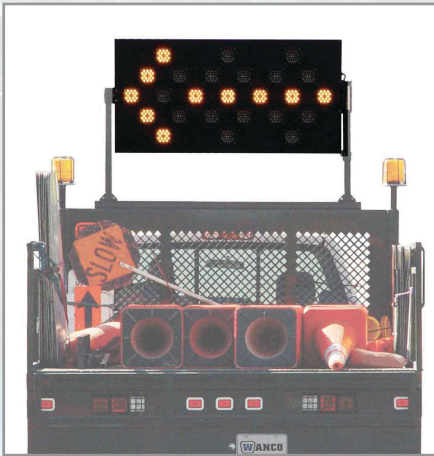

Truck Arrow Boards



Light Towers



AFAD - Flagging Device



Balloon Lights



X - Marker



Trailer & Truck TMA's



TMA's



Rumble Strips



Rumble Strips

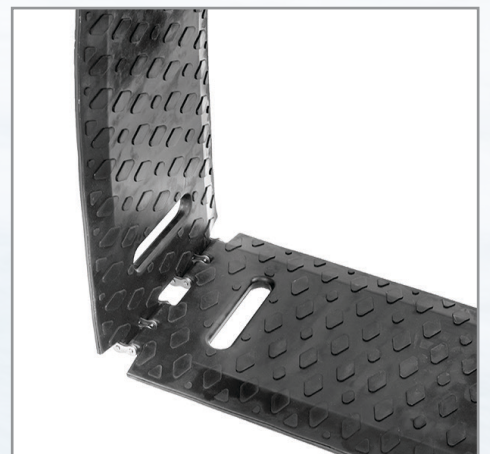

Rumble Strips

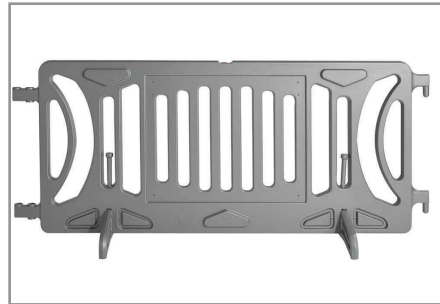
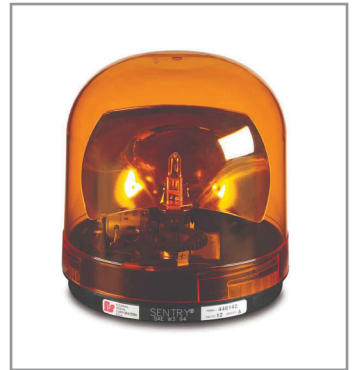



Mini Matrix for Public Safety



Signal Baton / Wand



Barrier Tape

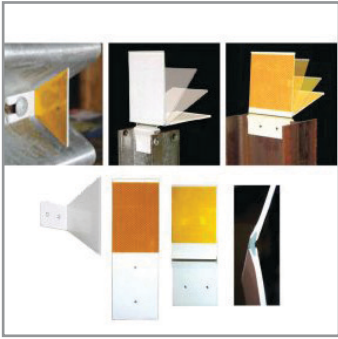

Guardrail Reflectors



Roadquake

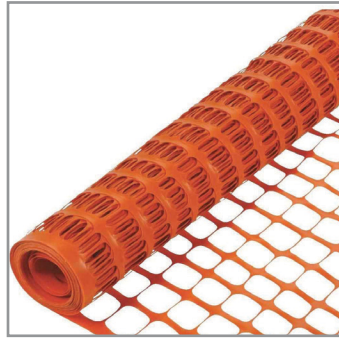

Safety Fence



Delineator Posts



Selectpunch Sidebar



Barricades

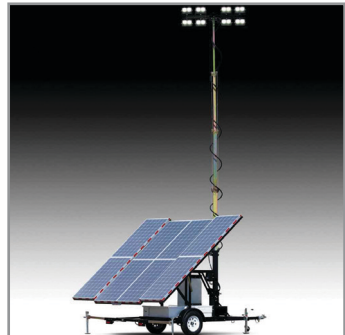

Surveillance Systems





Bid projects for City of Spokane, WSDOT, and ITD

We supply proper professional bid pricing for such projects. If you have plans for anything, send them to us and we can price it out accordingly.

Install City and County Spec Signs and Posts

We install many different types of signs including RADAR signs, permanent street signs, and construction signs for temporary application.



Manufacture Freeway Signs in Compliance with WSDOT

Our state-of-the-art sign shop can produce any kind of sign that your project needs including permanent signs, construction signs and a variety of signage to suite all of your needs.

Install School Zone Signs

We install custom School Zone signs, radar and/or caution beacons. Let us help you slow drivers down in the areas that are most important to you.



Install Windbeam on Signs when Required

Many signs in our region require "Wind Beam" bracing on the back of the signs. We have the capability to do that for you.

Car Stops / Wheel Stops

We have Concrete car stops and the rubber car stops. Not sure which ones you need? Our professional inside staff will assist you.



Bollards

We have many different types of Bollards. 2", 4", 6" and even 8" Bollards. Cut to any length and or size. We offer installation as well.

Striping Parking Lots

Our sister company can offer you some of the best striping out there. If you have a large parking lot, or if you just need one stall painted, we can help. Call for pricing.



Parking Lot Signs and Posts

If your project needs any kind of sign and/or post, we can offer that to you. Square tubing, round post and U-Channel are available as well.



6602 East Main Avenue
Spokane Valley, WA 99212
sales@nationalbarricadeandesign.com
(800) 459-7558 | Local: (509) 534-2619
Fax: (509) 534-2610

